

Coaxial Frequency Mixer

Level 7 (LO Power +7 dBm) 2000 to 4200 MHz

ZFM-4212+



SMA version shown
CASE STYLE: K18

Maximum Ratings

Operating Temperature	-55°C to 100°C
Storage Temperature	-55°C to 100°C
RF Power	50mW
IF Current	40mA

Permanent damage may occur if any of these limits are exceeded.

Coaxial Connections

LO	1
RF	2
IF	3

Features

- low conversion loss, 5.44 dB typ.
- wideband, 2000 to 4200 MHz
- rugged shielded case

Applications

- VHF/UHF
- MMDS
- ISM
- instrumentation

Connectors	Model
SMA	ZFM-4212+
BRACKET (OPTION "B")	

+RoHS Compliant
The +Suffix identifies RoHS Compliance. See our web site for RoHS Compliance methodologies and qualifications

Outline Drawing

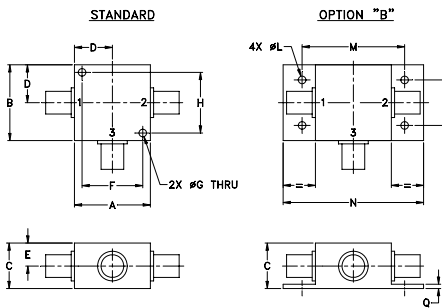

Outline Dimensions (inch/mm)

A	B	C	D	E	F	G	H
1.25	1.25	.75	.63	.38	1.00	.125	1.000
31.75	31.75	19.05	16.00	9.65	25.40	3.18	25.40
J	K	L	M	N	P	Q	wt
--	--	.125	1.688	2.18	.75	.07	grams
--	--	3.18	42.88	55.37	19.05	1.78	70.0

Electrical Specifications

FREQUENCY (MHz)	CONVERSION LOSS (dB)	LO-RF ISOLATION (dB)		LO-IF ISOLATION (dB)	
		Typ.	Min.	Typ.	Min.
2000-4200	DC-1300	25	17	18	10

1 dB COMP.: +1 dBm typ.

Typical Performance Data

Frequency (MHz)	Conversion Loss (dB)	Isolation L-R (dB)	Isolation L-I (dB)	VSWR RF Port (:1)	VSWR LO Port (:1)
2000.00	1940.00	5.05	25.30	1.99	6.73
2043.75	1983.75	5.10	25.30	1.99	6.26
2187.50	2127.50	5.57	23.60	1.99	5.85
2331.25	2271.25	5.78	24.40	1.91	6.05
2475.00	2415.00	5.92	26.50	2.01	6.49
2618.75	2558.75	5.81	27.70	2.35	6.49
2762.50	2702.50	5.64	28.30	2.43	6.49
2906.24	2846.24	5.68	28.10	2.37	6.26
3000.00	2940.00	5.85	28.70	2.40	6.73
3050.00	2990.00	5.85	28.10	2.43	7.60
3193.75	3133.75	5.82	27.20	18.70	8.72
3337.50	3277.50	5.56	26.70	19.20	8.31
3481.25	3421.25	5.52	27.40	17.90	8.72
3625.00	3565.00	5.73	27.40	16.50	5.49
3768.75	3708.75	6.35	27.10	16.00	4.32
3912.50	3852.50	6.33	28.60	15.60	4.53
4000.00	3940.00	6.09	29.90	15.50	4.42
4056.25	3996.25	5.82	30.50	15.40	4.32
4119.00	4059.00	5.84	30.60	15.20	4.12
4200.00	4140.00	5.64	30.60	14.70	4.32

Electrical Schematic

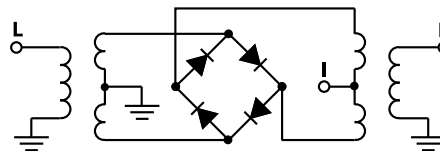

Notes

- Performance and quality attributes and conditions not expressly stated in this specification document are intended to be excluded and do not form a part of this specification document.
- Electrical specifications and performance data contained in this specification document are based on Mini-Circuit's applicable established test performance criteria and measurement instructions.
- The parts covered by this specification document are subject to Mini-Circuits standard limited warranty and terms and conditions (collectively, "Standard Terms"); Purchasers of this part are entitled to the rights and benefits contained therein. For a full statement of the Standard Terms and the exclusive rights and remedies thereunder, please visit Mini-Circuits' website at www.minicircuits.com/MCLStore/terms.jsp



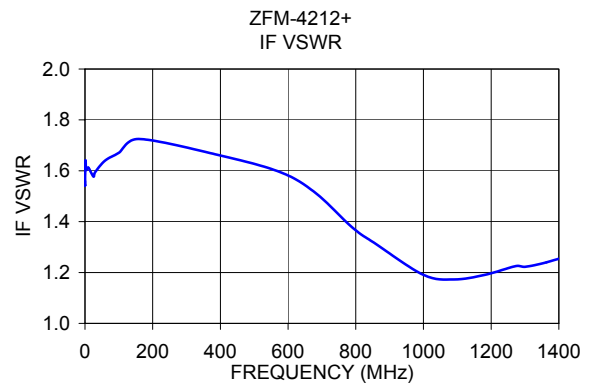
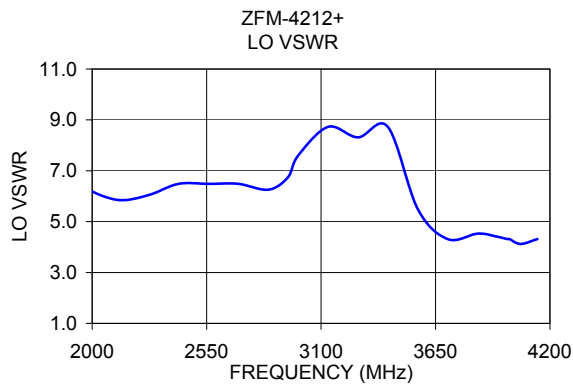
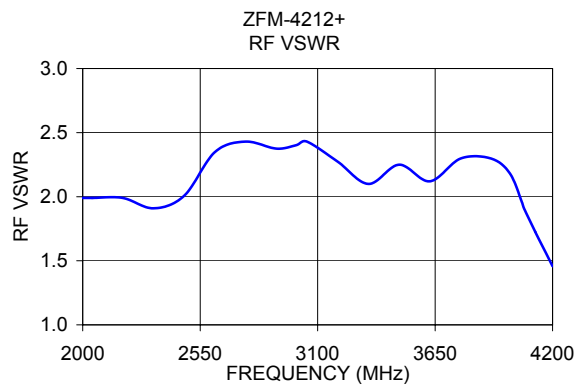
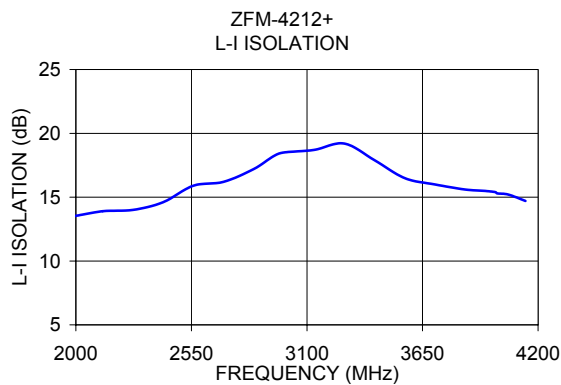
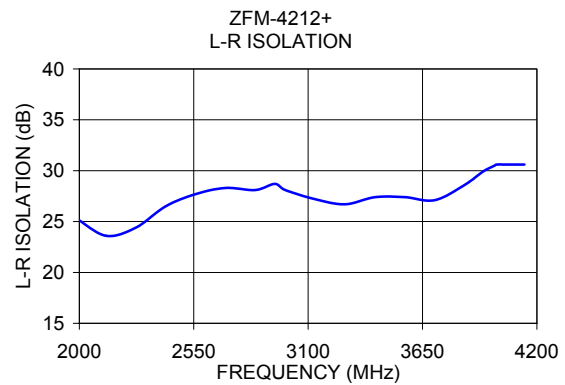
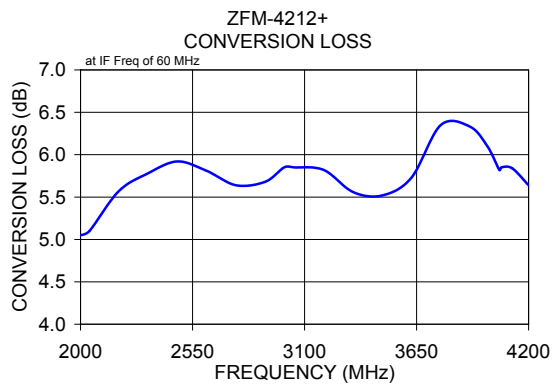

Notes

- A. Performance and quality attributes and conditions not expressly stated in this specification document are intended to be excluded and do not form a part of this specification document.
- B. Electrical specifications and performance data contained in this specification document are based on Mini-Circuit's applicable established test performance criteria and measurement instructions.
- C. The parts covered by this specification document are subject to Mini-Circuits standard limited warranty and terms and conditions (collectively, "Standard Terms"); Purchasers of this part are entitled to the rights and benefits contained therein. For a full statement of the Standard Terms and the exclusive rights and remedies thereunder, please visit Mini-Circuits' website at www.minicircuits.com/MCLStore/terms.jsp